

Spot Light

 **FLSP-i60**

Lighting Picture



Lighting Dimension

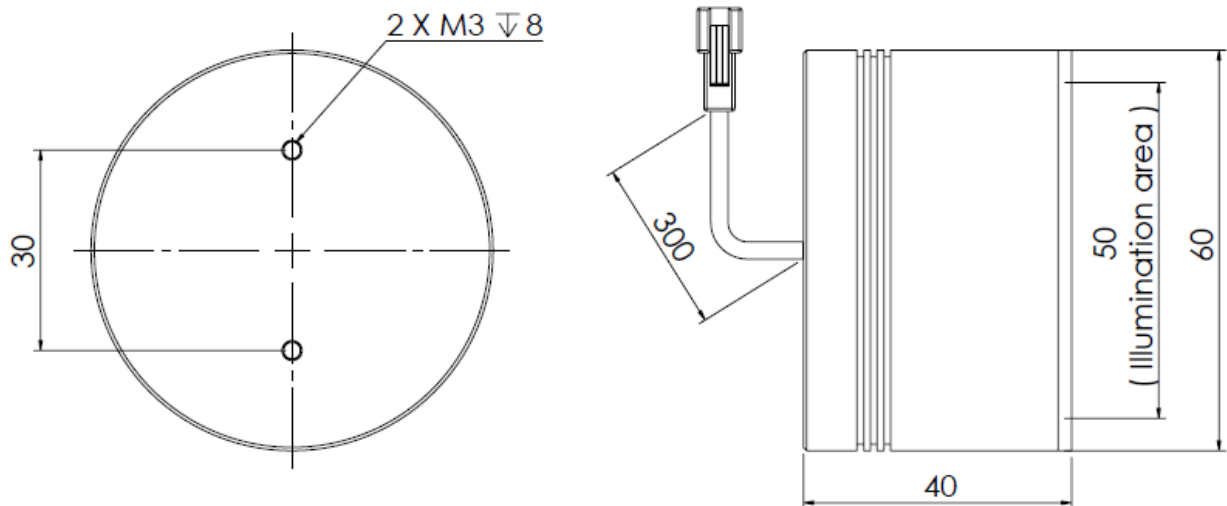

All unit in mm

Mechanical Information	
Casing Material	Aluminium + Arcylic
Storage Temperature Range	Temp 0-35°C, Humidity 20-85%
Weight	235 g
Lighting Dimension, ØxH	60.0 x 40.0 mm
IP Rating	IP 30



Optical Information				
Led Color	RED (R24)	GREEN (G)	BLUE (B)	WHITE (W)
Wavelength	626nm	525nm	470nm	xy=(0.31,0.32)
Number of LED	40	42		
Illumination Area	Ø50 mm			
Led Package	T1 ¾ (5mm)			
Eye Safety (EN 62471:2008)	Exempt Group			
Electrical Information				
	R24		G/B/W	
Lighting Supply Voltage (constant voltage mode)	24V ± 2%			
Supply Ripple Voltage	≤ Vs ± 5%			
Reverse Battery Protection	YES			
Lighting Forward voltage, (for zero internal resistor value)	22.0 V		22.4 V	
Continuous Current	0.12 A (MAX)		0.18 A (MAX)	
Power Consumption	2.88 Watts		4.32 Watts	
Lighting casing temperature, Operating after 60 minutes	44°C		46°C	
Strobe Mode Specification				
	R24		G/B/W	
Max. Lighting Supply Voltage (Constant voltage power supply)	Pulsing at 24VDC to 48VDC, 0-10% Duty Cycle Recommended at 36VDC			
Pulse Current, (Max. 10msec) (Constant current power supply)	0.3 A (MAX)		0.45 A (MAX)	
Max. Trigger Pulse Duration, msec	10 msec			
Duty Cycle	0 to 10%			
Additional Information				
Additional Cooling Method	Attached to machine part for better heat dissipation			
Life span in continuous mode	20,000 hours (drop to 50% intensity) at 25°C			
Life span in strobe light mode	Est. >50,000 hours (drop to 50% intensity) at 25°C			
Intensity Controller Selection	PSA-Series, LIC-Series			
CE Conformity	YES			
RoHS Compliance	YES			
ISO 9001:2008	SG11/03751			
Ordering Option				
FLSP-i60-R24/G/B/W	With resistor to limit the current (Use with both constant voltage/ current power supply)			
FLSP-i60-R24/G/B/W-0	Internal resistor value= zero ohms (only use with constant current power supply)			
Connection				
Connector Type:	JST SMR-03V			
Cable Length out from lighting:	300 mm			
Pin Configuration:	Pin	Signal	Cable Color	
	1	LED +	Black/White	
	2	N.C.	---	
	3	LED -	Black	
				
Application				
Optimal Working Distance	5-100mm			



Disclaimer

IMPORTANT NOTICE:

ALL PRODUCT, PRODUCT DATA SHEET AND DATA ARE SUBJECT TO CHANGE WITHOUT NOTICE TO IMPROVE QUALITY, RELIABILITY, FUNCTION, DESIGN OR OTHERWISE.

Other disclaimers:

- 1) FALCON ILLUMINATION (M) SDN.BHD, Formerly known as LED ILLUMINATION (M) SDN.BHD (termed as FALCON), its affiliates, agents, distributors and employees, and all persons acting on its or their behalf (FALCON collectively), disclaim any and all liability for any errors, inaccuracies or incompleteness contained in any datasheet or in any other disclosure relating to any product.
- 2) FALCON makes no warranty, representation or guarantee regarding the suitability of the products for any particular purpose or the continuing production of any product. To the maximum extent permitted by applicable law, FALCON disclaims:
 - (i) any and all liability arising out of the application or use of any product,
 - (ii) any and all liability, including without limitation special, consequential or incidental damages, and
 - (iii) any and all implied warranties, including warranties of fitness for particular purpose, non-infringement and merchantability.
- 3) Information and statements regarding the suitability of products for certain types of applications are based on FALCON's knowledge of typical requirements that are often placed on our products datasheet for generic applications. Such statements or information are not binding statements about the suitability of products for a particular application. It is the customer's responsibility to verify and/or validate that a particular product with the properties described in our product data sheet is suitable for use in a particular application.
- 4) Parameters provided in product datasheets and/or specifications may vary in different applications and performance may vary over time. All operating parameters, including typical parameters, must be verified and/or validated for each customer application by the customer's technical experts.
- 5) Except as expressly indicated in writing, FALCON l's products are not designed for use in medical, life-saving, or life-sustaining applications or for any other application in which the failure of the product could result in personal injury or death. Customers using or selling our products not expressly indicated for use in such applications do so at their own risk and agree to fully indemnify and hold FALCON and its distributors harmless from and against any and all claims, liabilities, expenses and damages arising or resulting in connection with such use or sale, including attorneys fees, even if such claim alleges that FALCON or its distributor was negligent regarding the design or manufacture of the part. Please contact authorized FALCON personnel to obtain written terms and conditions regarding products designed for such applications.

